

Ultra High Performance BGA Cooling Solutions w/ maxiGRIP™ Attachment*

DIGI-KEY PART # ATS1018-ND

ATS PART # ATS-50210G-C2-R0

Features & Benefits

maxiFLOW™ design features a low profile, spread fin array that maximizes surface area for more effective convection (air) cooling

maxiGRIP™ attachment applies steady, even pressure to the component and does not require holes in the PCB

Meets Telcordia GR-63-Core Office Vibration; ETSI 300 019 Transportation Vibration; and MIL-STD-810 Shock and Unpackaged Drop Testing standards

Comes preassembled with high performance, phase changing, thermal interface material

Designed for standard height components from 3 to 4.5mm

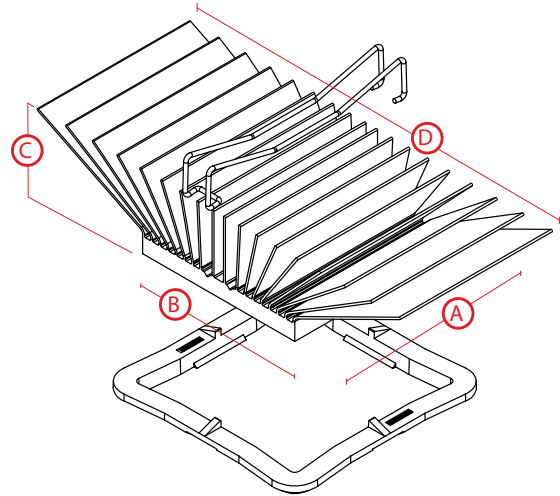

Thermal Performance Table

AIR VELOCITY		THERMAL RESISTANCE	
FT/MIN	M/S	°C/W (UNDUCTED)	°C/W (DUCTED)
200	1.0	7.2	5.7
300	1.5	5.9	
400	2.0	5.1	
500	2.5	4.6	
600	3.0	4.2	
700	3.5	3.9	
800	4.0	3.7	

Product Details†

DIMENSION A	DIMENSION B	DIMENSION C§	DIMENSION D	TIM‡	FINISH
21	21	12.5	38.16	C1100F	BLUE-ANODIZED

For further technical information, please contact Advanced Thermal Solutions, Inc. at **1-781-769-2800** or www.qats.com

* RoHS Compliant

‡ TIM = Thermal Interface Material

† Dimensions are measured in millimeters

◆ Dimensions A & B refer to component size

§ Dimension C = the height of the heat sink shown above and does not include the height of the attachment method



ATS ADVANCED THERMAL SOLUTIONS, INC.

Innovations in Thermal Management®



To place an order, please visit www.digikey.com